

Letter formation, directionality and placement are taught through a visual, auditory, kinesthetic, and tactile process.

Process:

1. Student places index finger of the writing hand on the starting dot.
- *2. Student follows the arrow while saying the movement out loud in a sing-song voice.

*Movement	Model	Saying
1. Half Circle (open circle)		“swing”
2. Full Circle (closed circle)		“swinging”
3. Vertical or slanted line from dotted line to bottom line		“slide”
4. Vertical or slanted line from the top solid line through the dotted line to the bottom solid line		“sliding”
5. Pulling up from the bottom solid line to the middle dotted line		“climb”
6. Pulling up from the solid bottom line through the middle dotted line to the top solid line		“climbing”
7. Any stroke that is not <u>circular</u> , <u>vertical</u> , or that <u>falls below the bottom</u> <u>solid line</u>		“whoops”

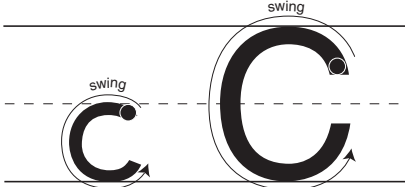
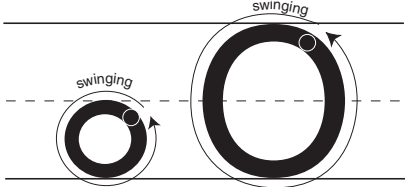
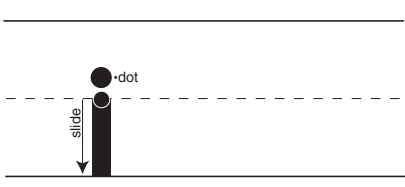
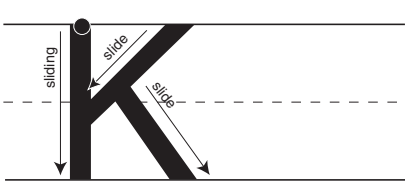
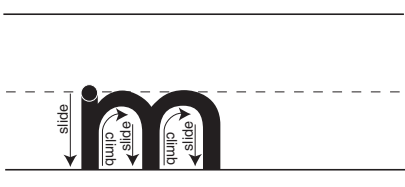
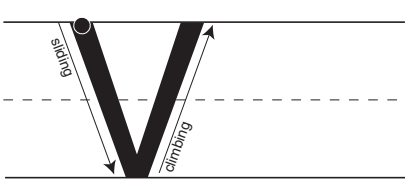
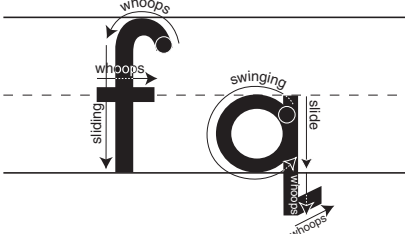
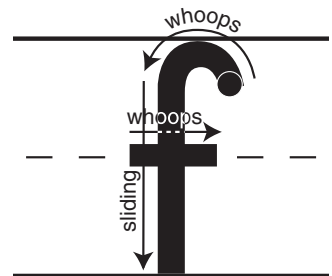
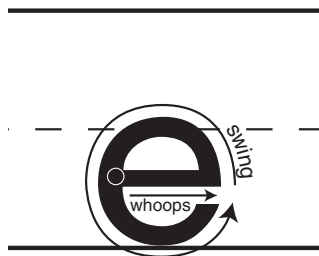
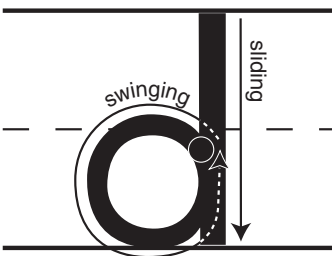
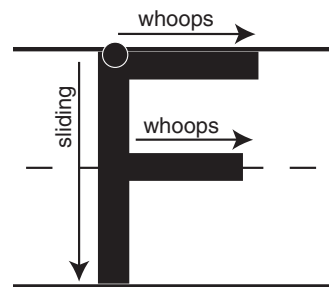
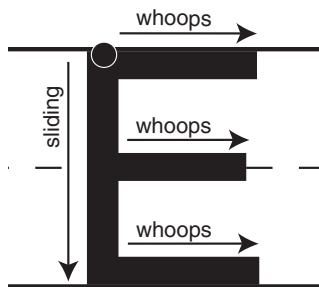
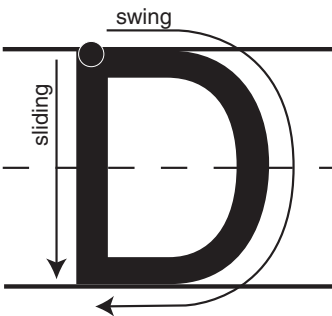
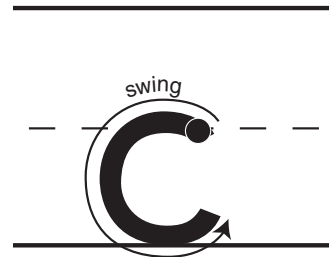
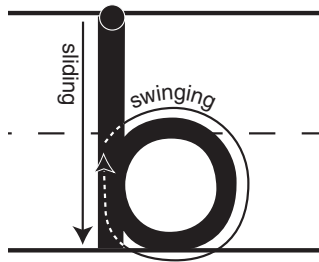
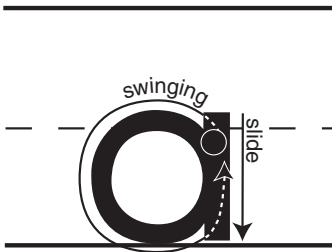
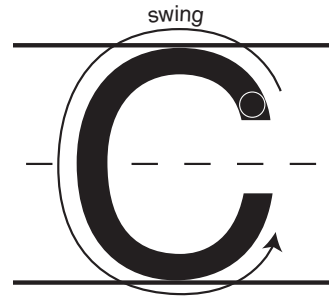
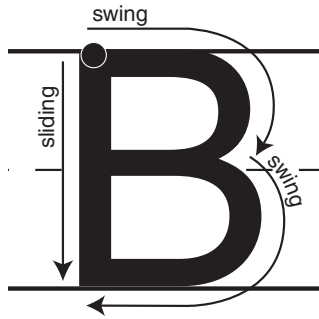
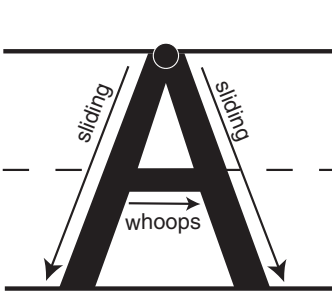

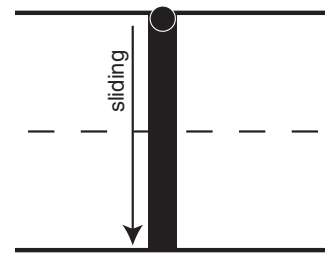
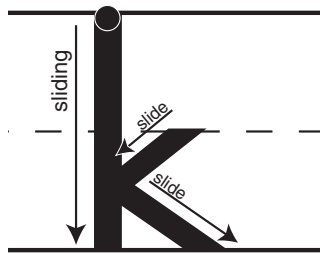
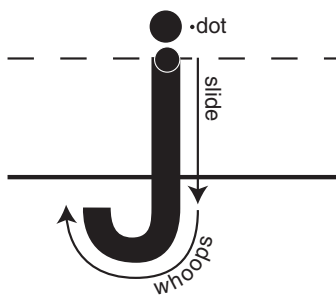
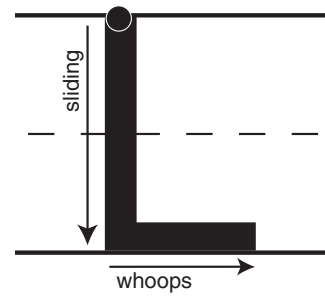
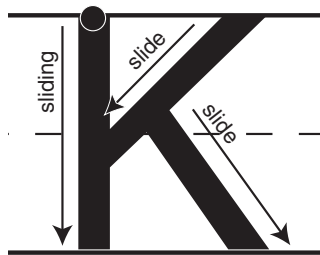
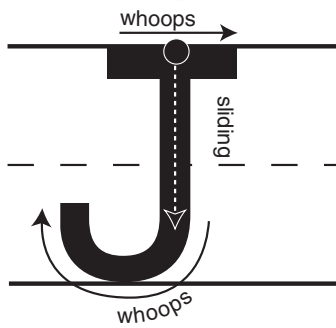
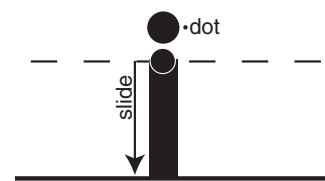
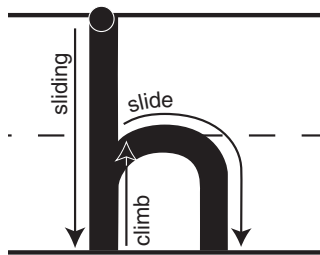
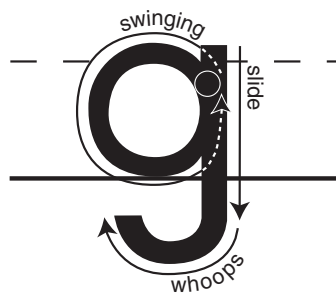
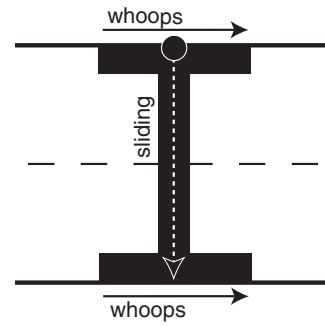
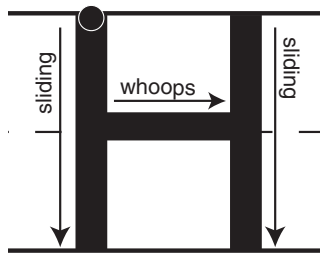
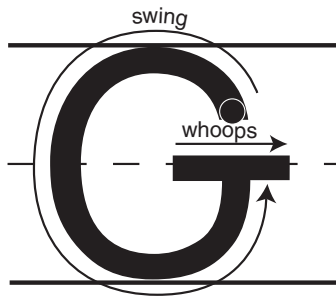

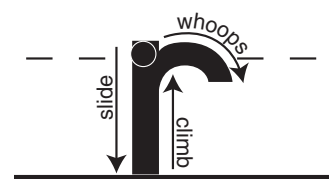
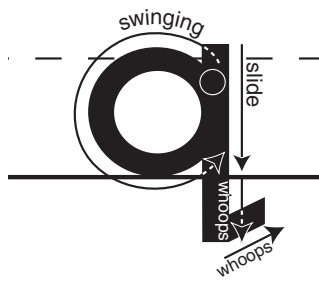
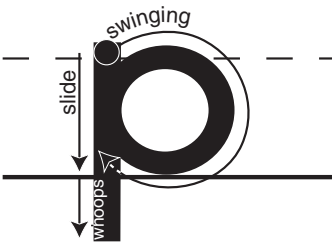
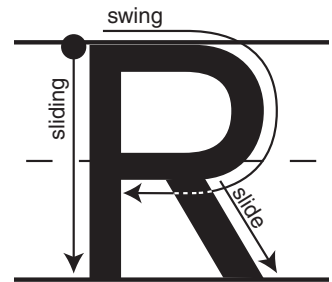
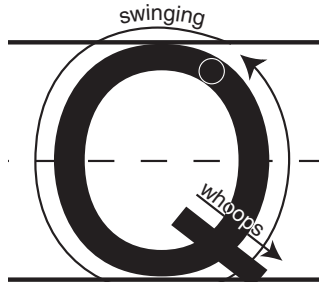
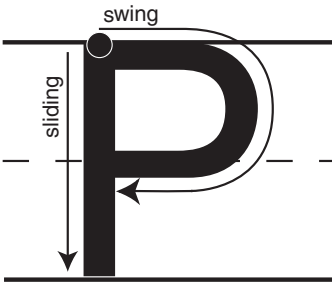
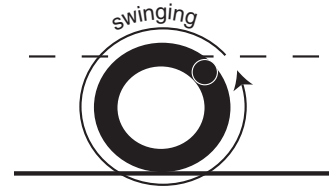
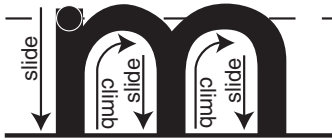
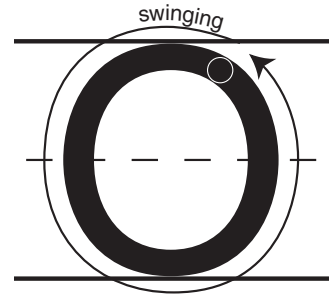
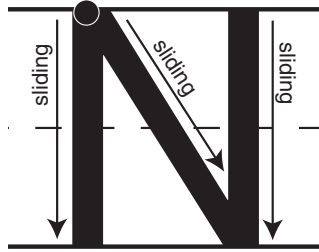
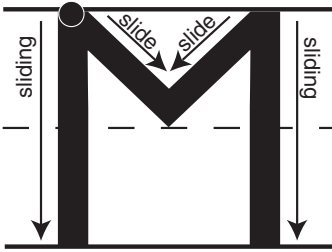

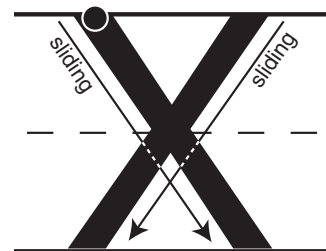
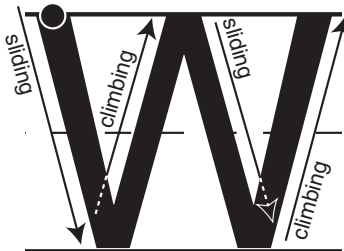
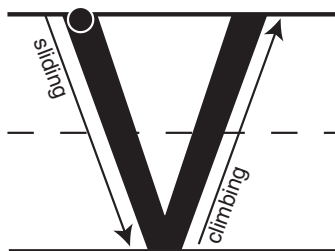
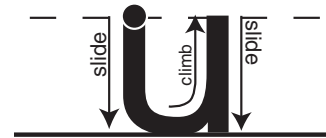
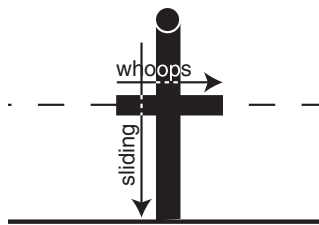
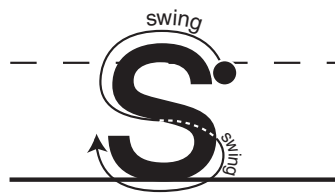
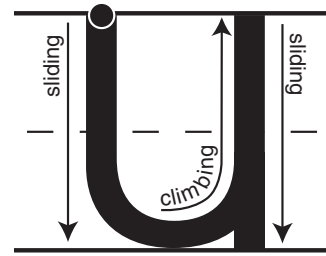
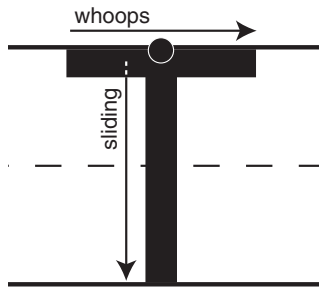
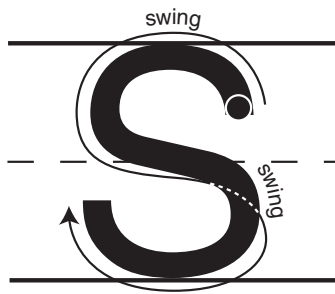

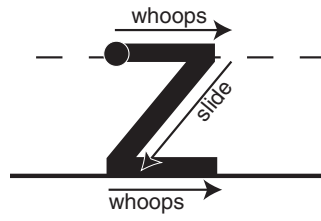
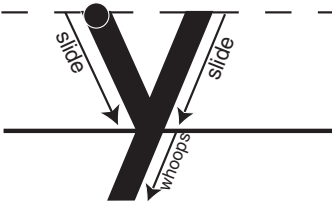
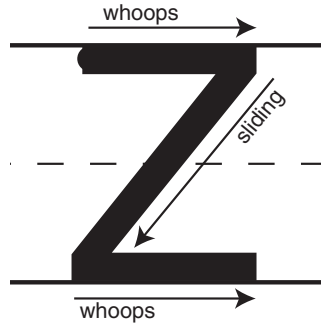
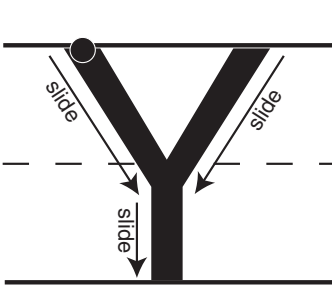

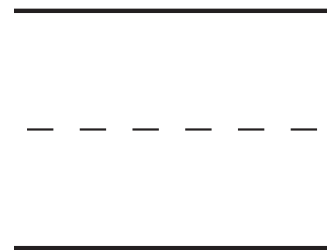
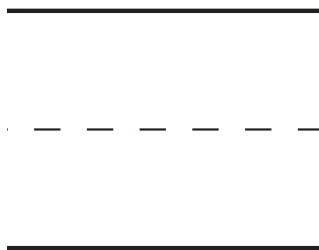
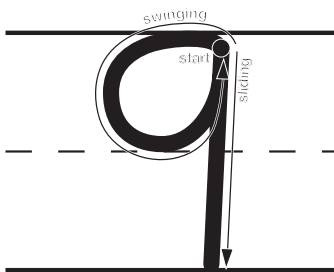
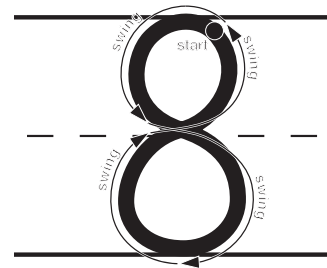
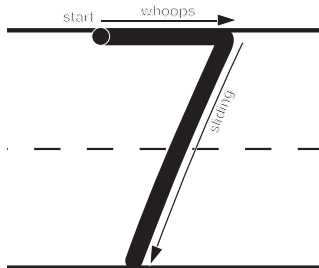
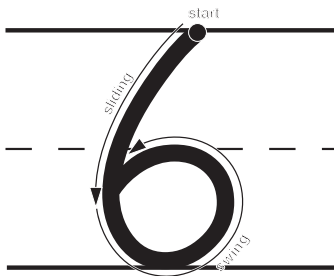
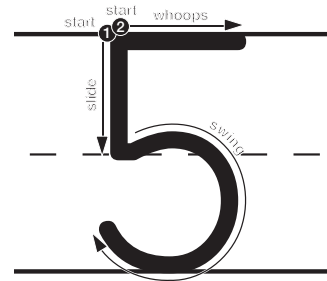
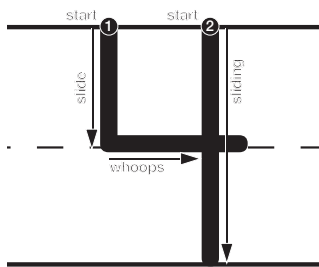
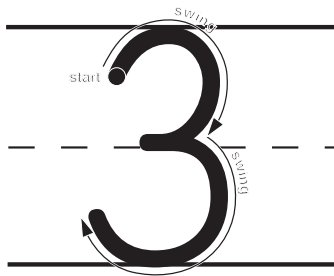
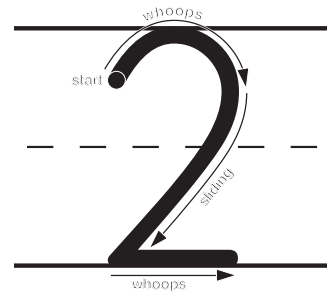
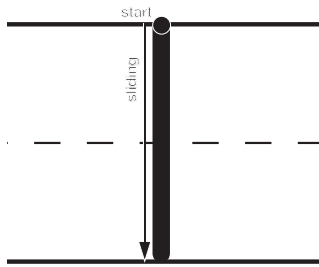
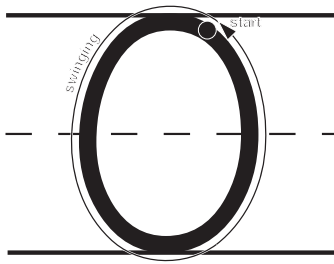

Practice Sheet

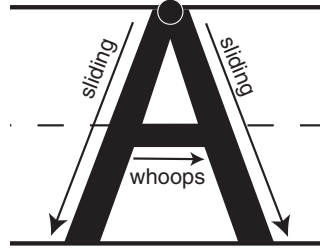
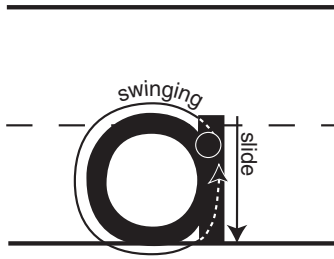

Name _____

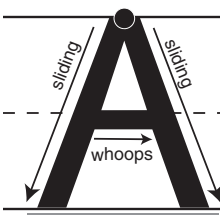
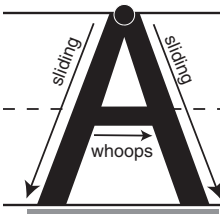
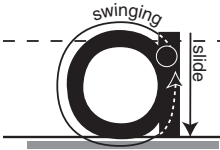
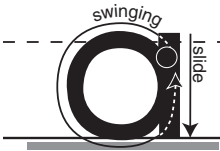

Practice Sheet

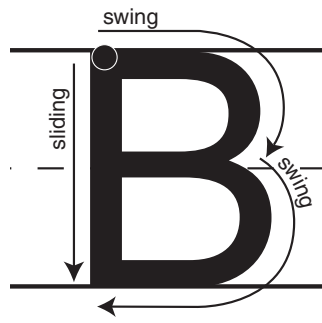
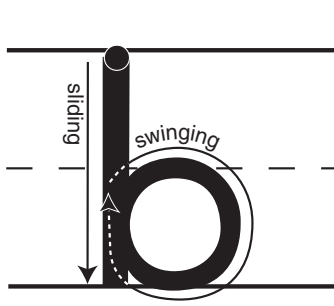

Name _____

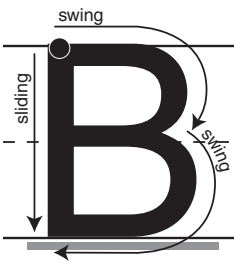
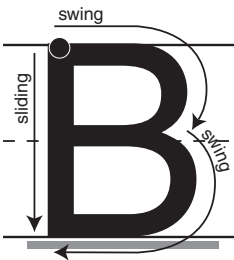
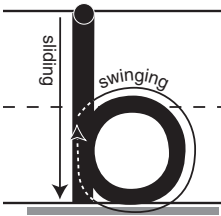
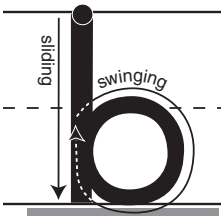

Practice Sheet

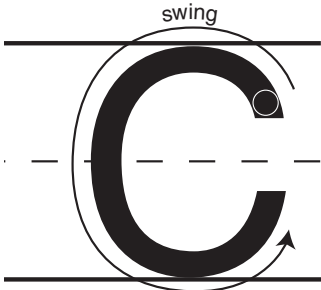
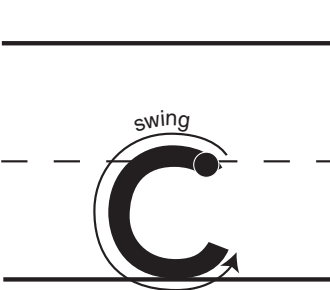

Name _____

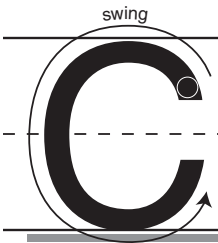
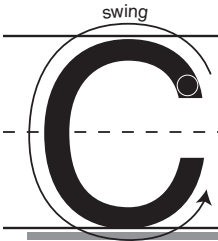
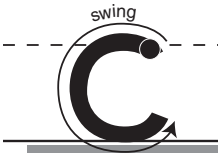
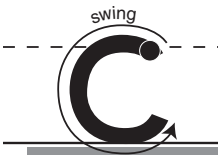

Practice Sheet

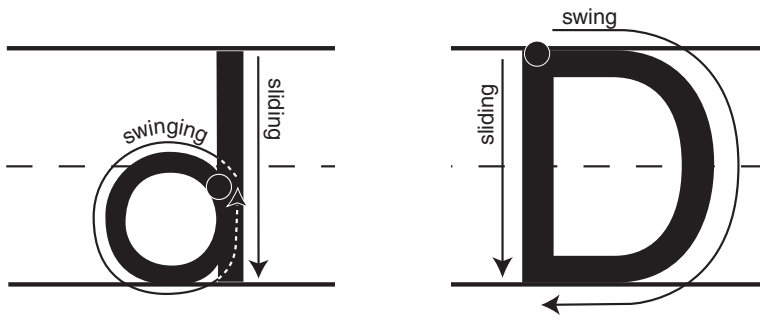

Name _____

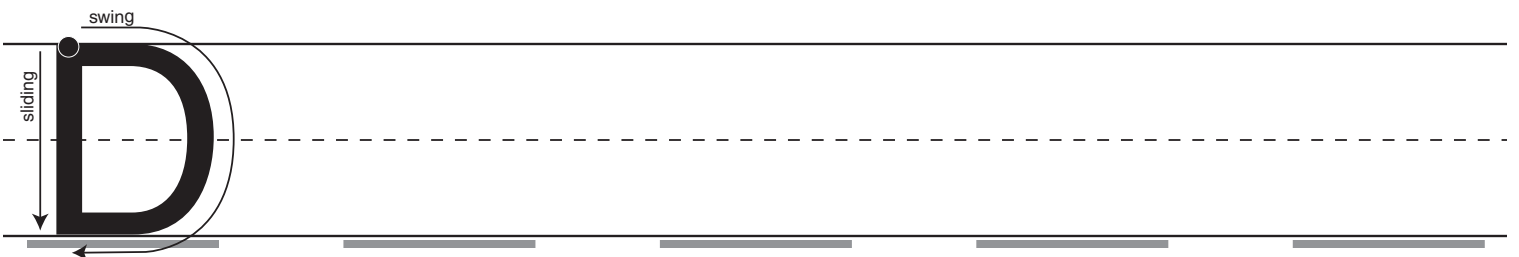
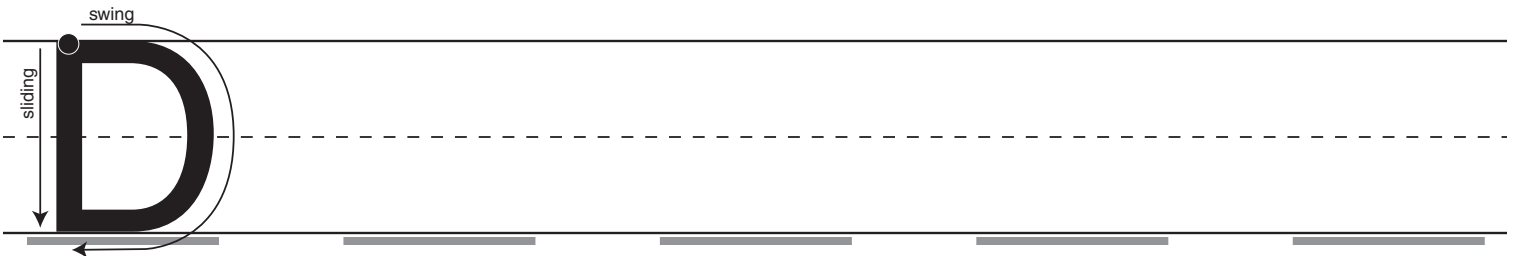
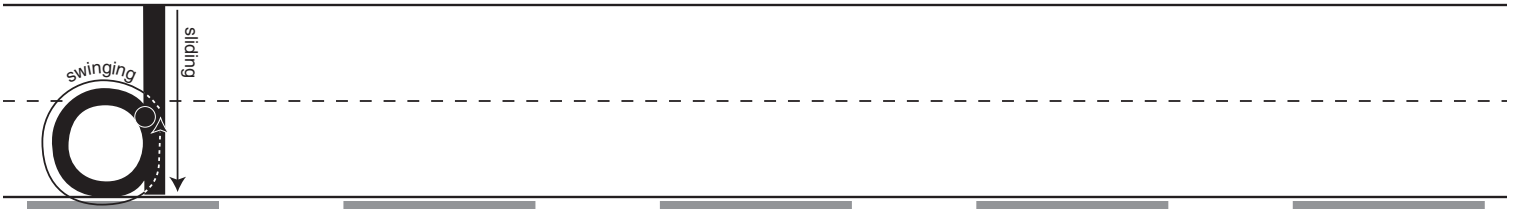

Practice Sheet

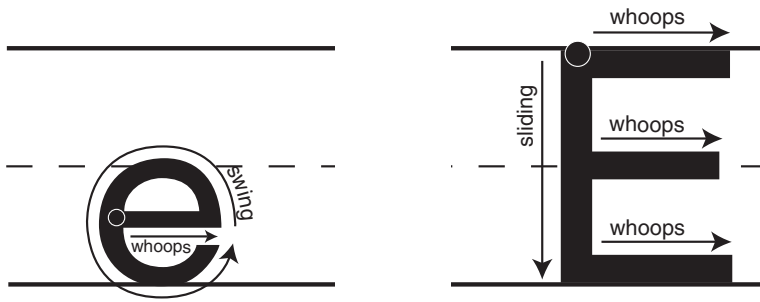

Name _____

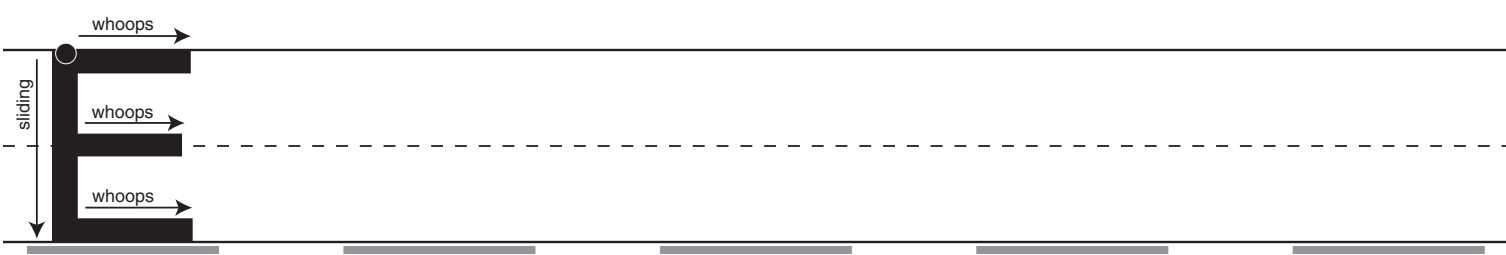
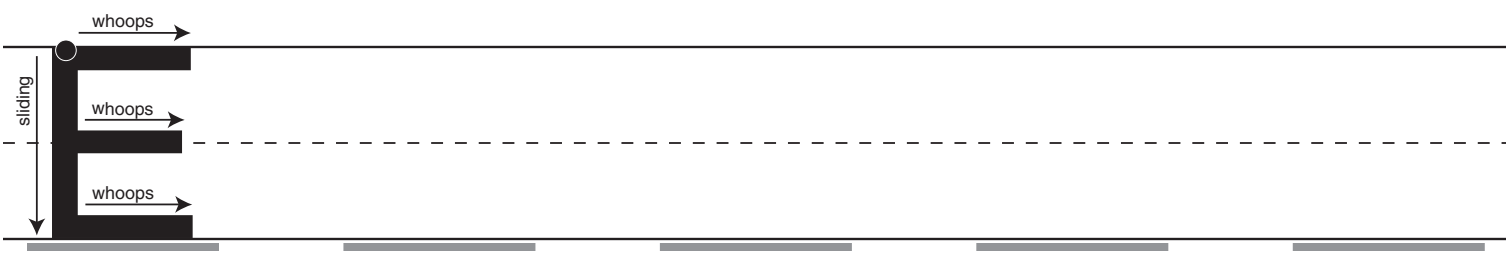
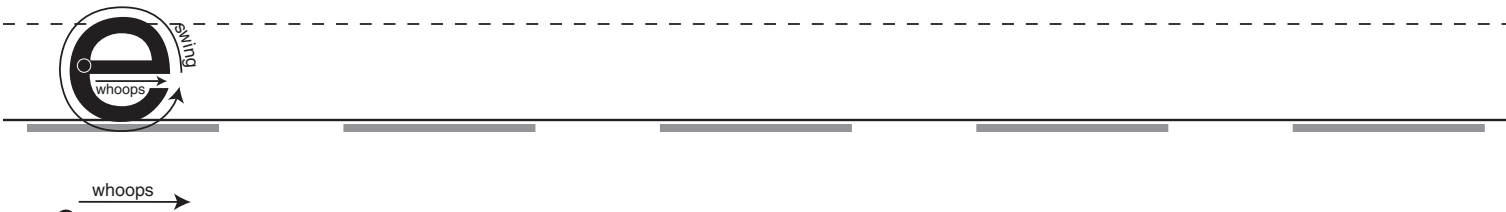
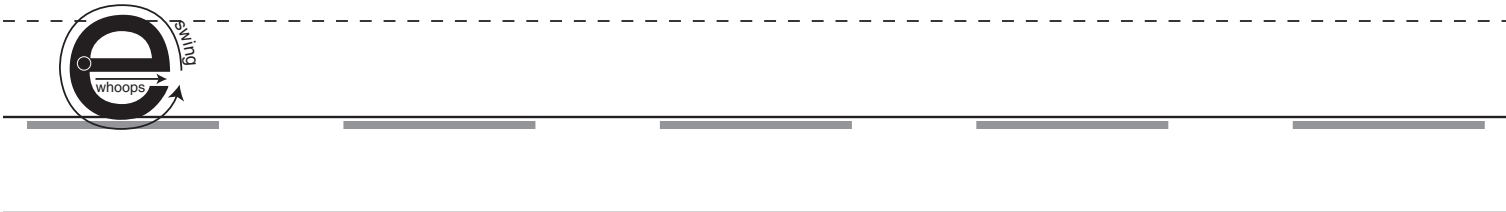

Practice Sheet

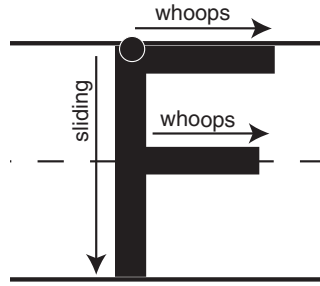
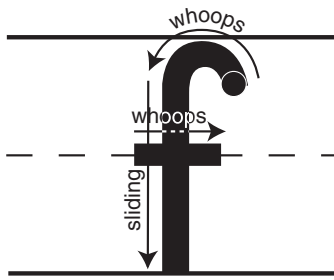

Name _____

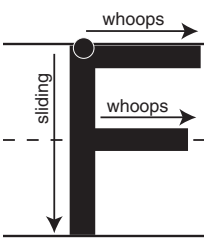
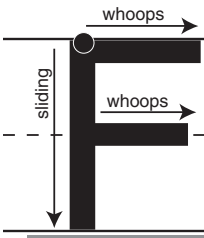
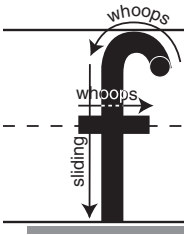
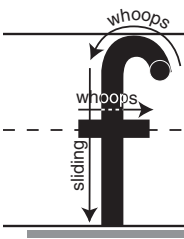

Practice Sheet

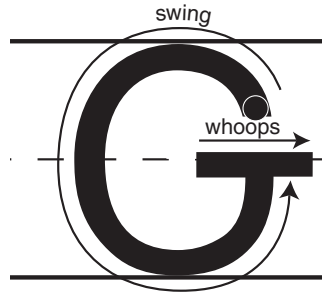
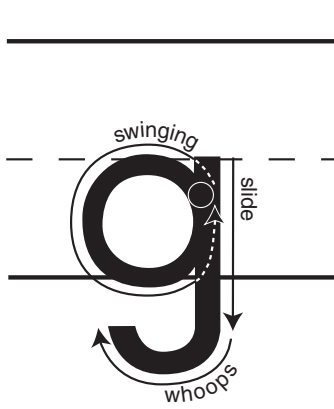

Name _____

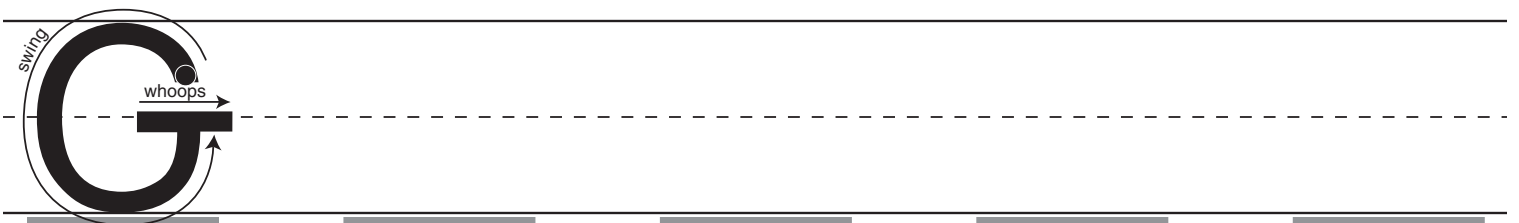
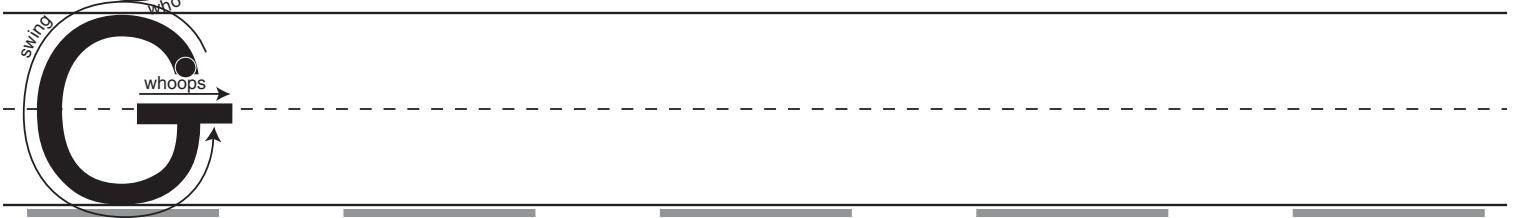
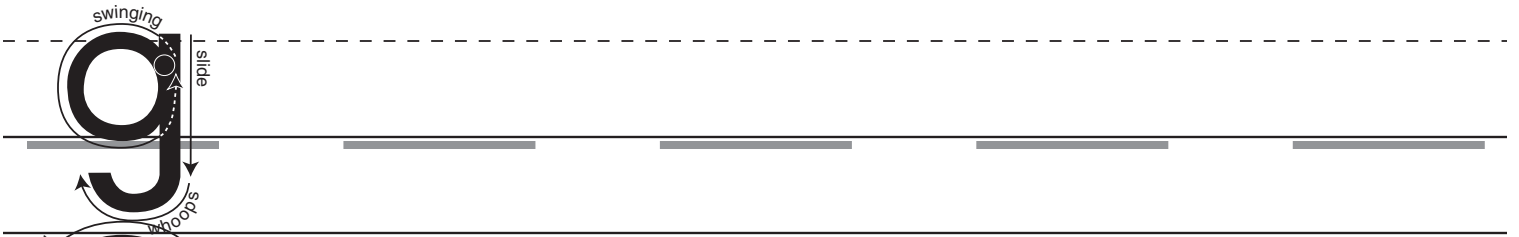

Practice Sheet

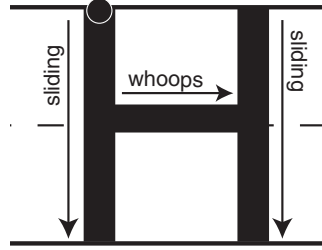
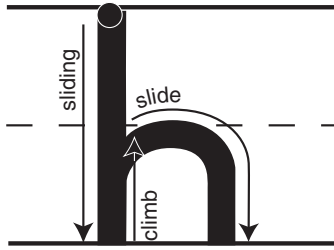

Name _____

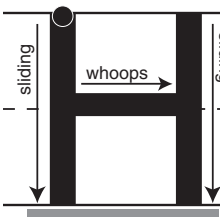
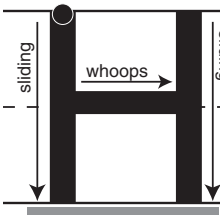
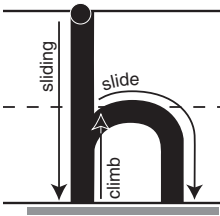
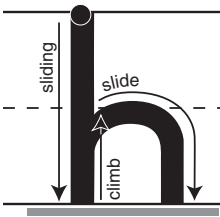

Practice Sheet

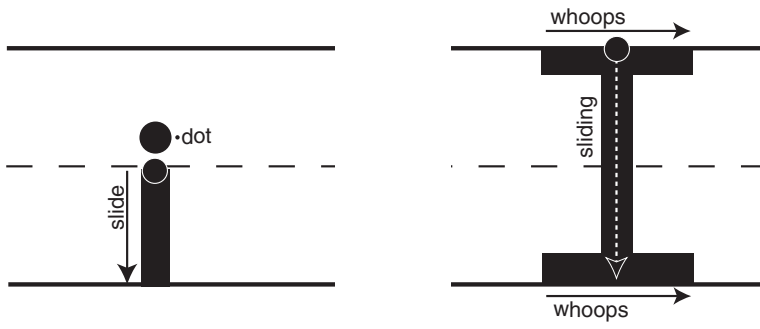

Name _____

Practice Sheet

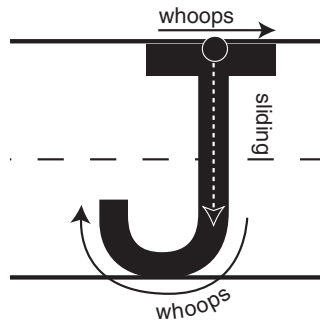
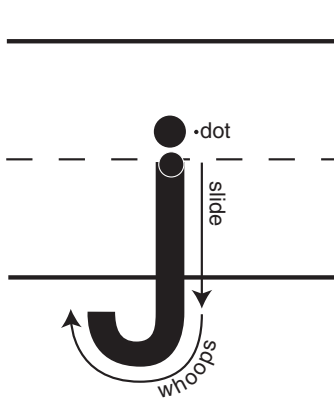

Name _____

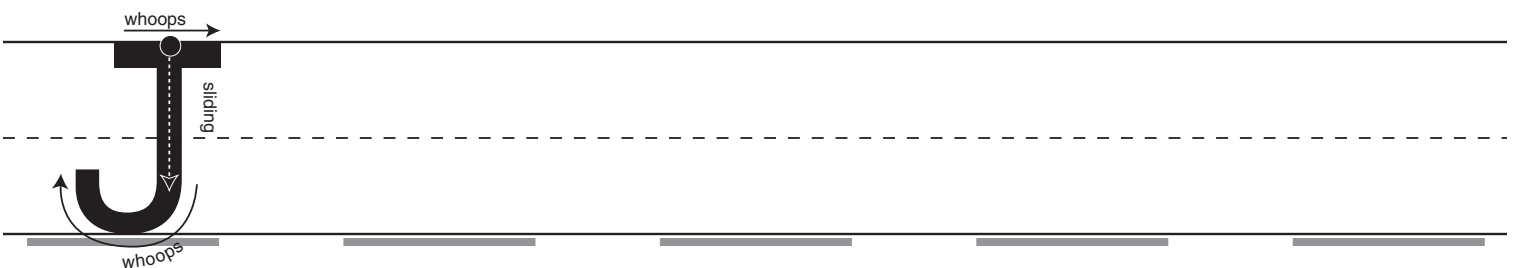
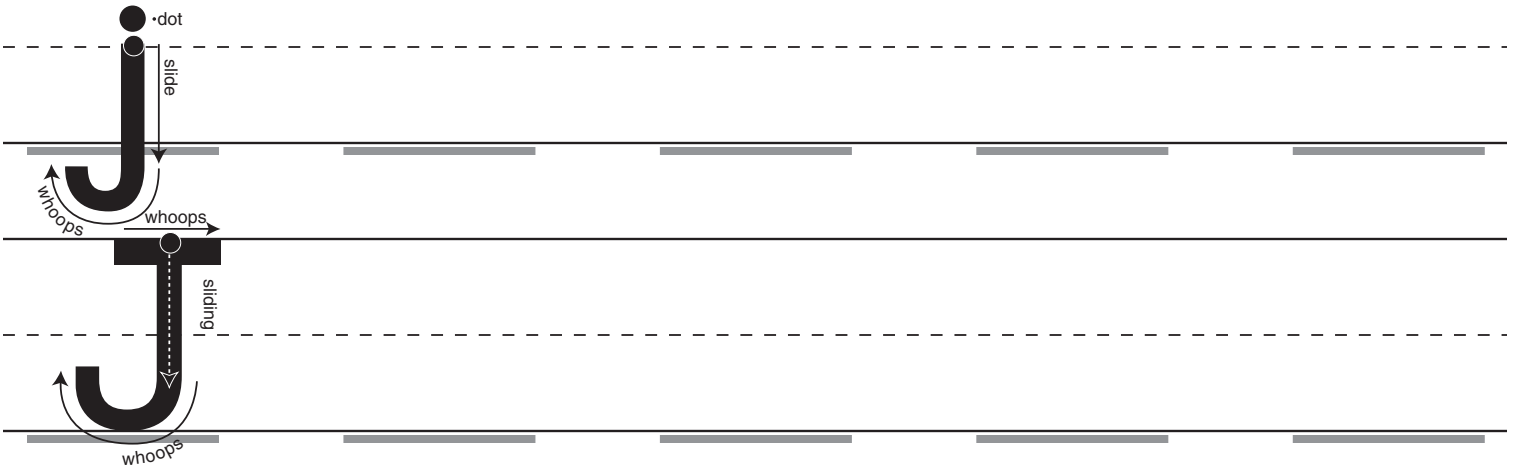

Practice Sheet

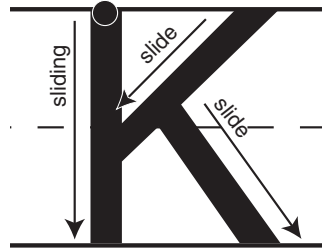
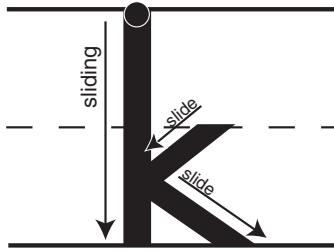

Name _____

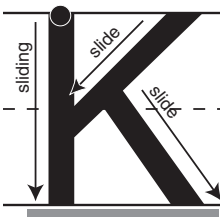
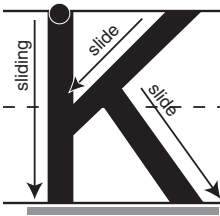
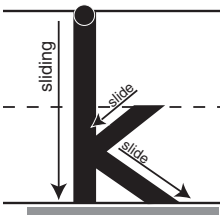
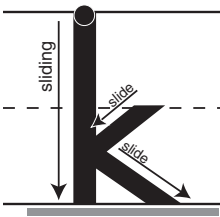

Practice Sheet

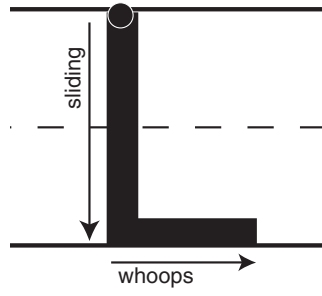
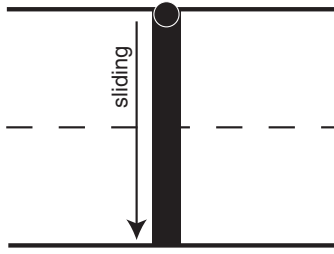

Name _____

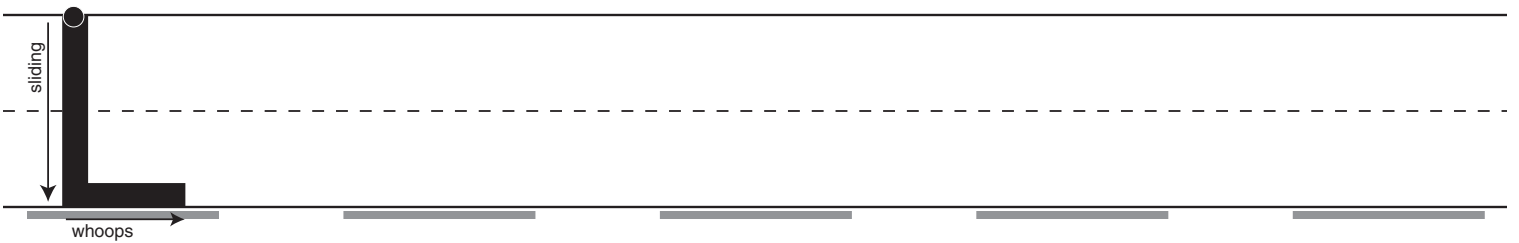
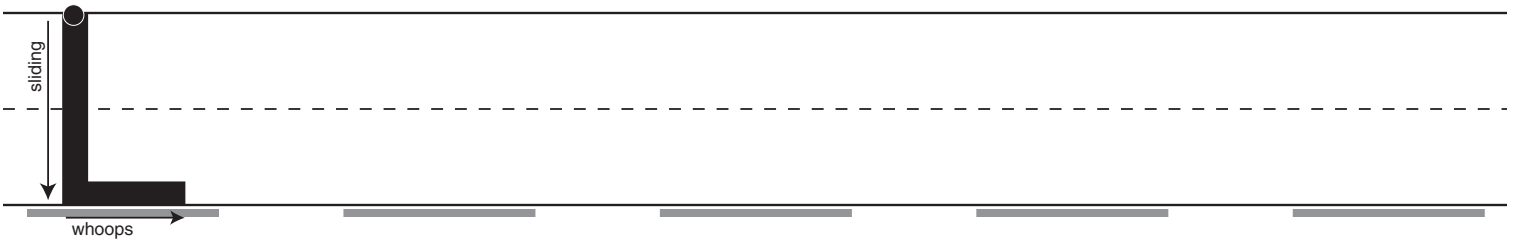
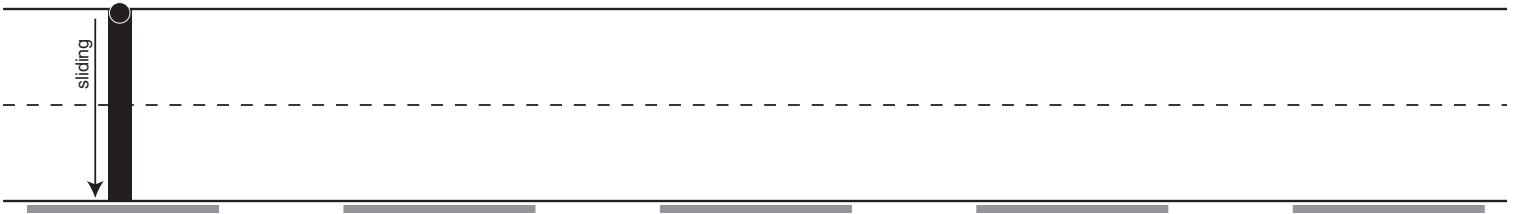

Practice Sheet

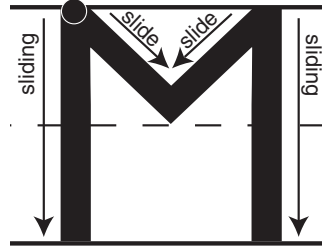
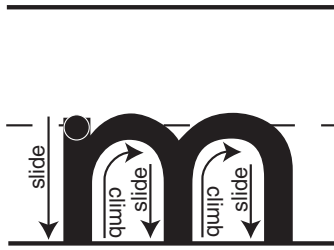

Name _____

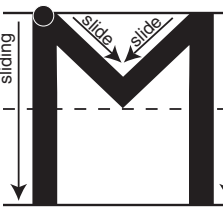
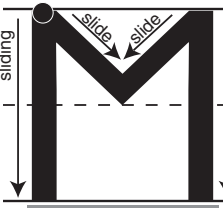
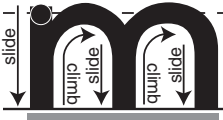
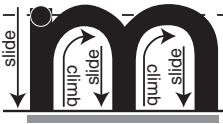

Practice Sheet

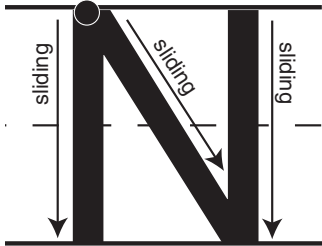
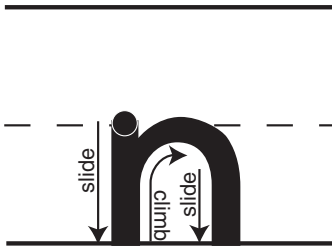

Name _____

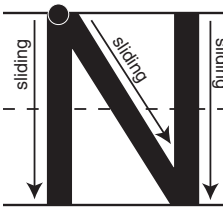
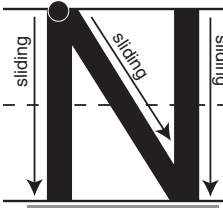
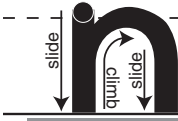
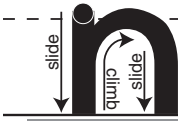

Practice Sheet

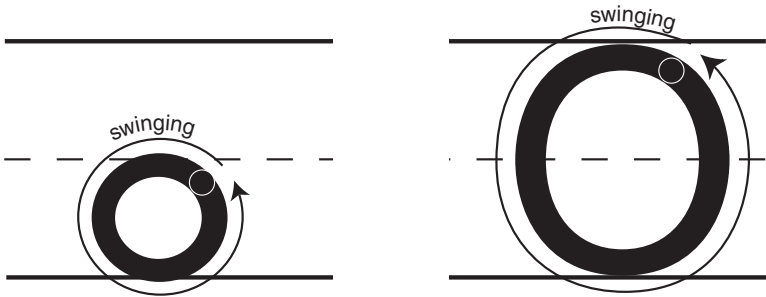

Name _____

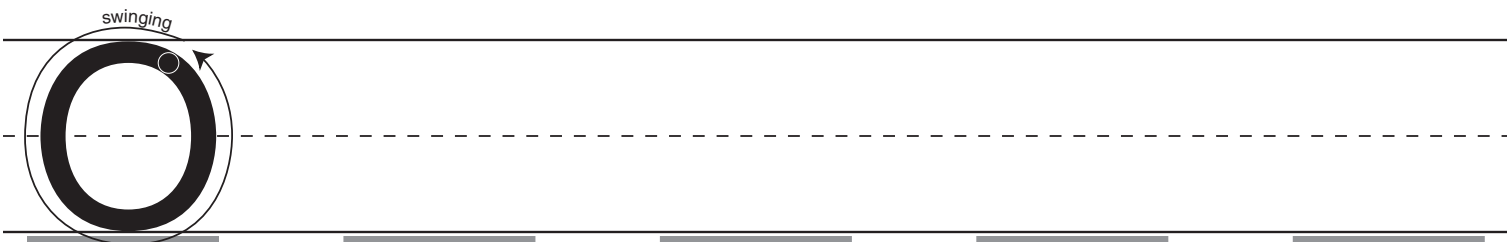
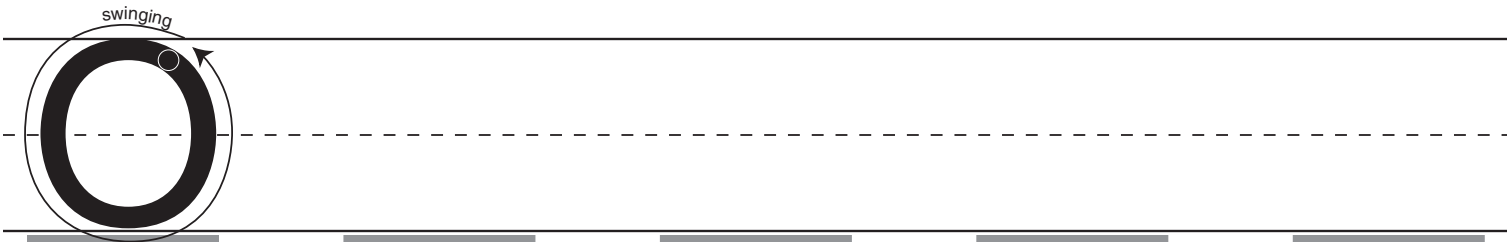
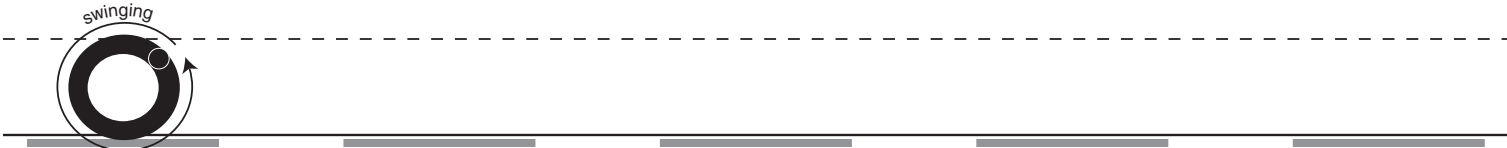
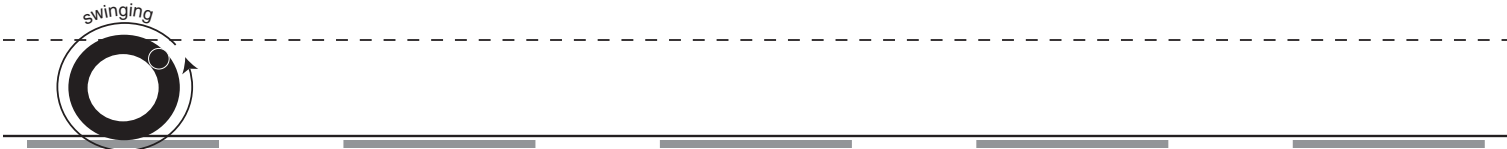

Practice Sheet

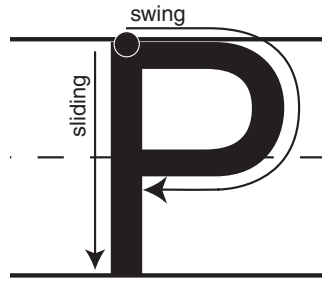
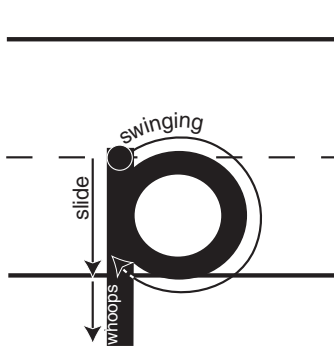

Name _____

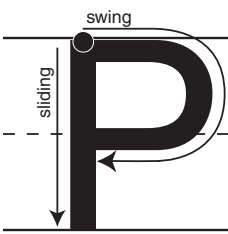
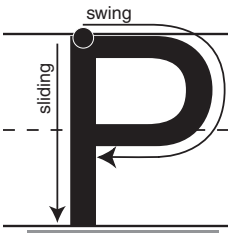
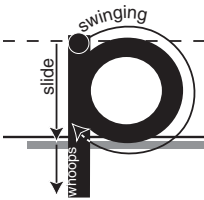
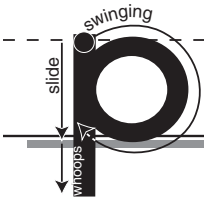

Practice Sheet

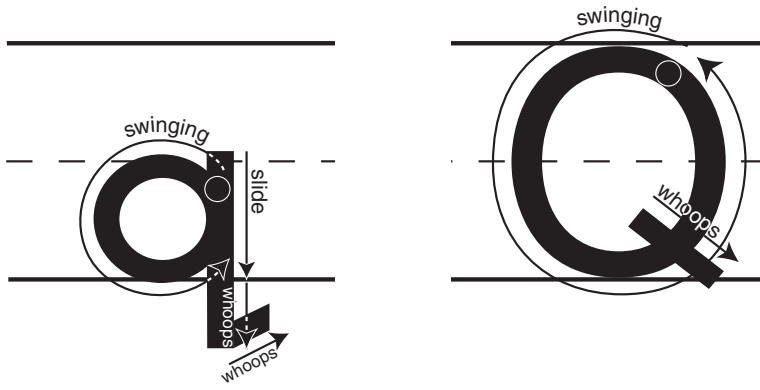

Name _____

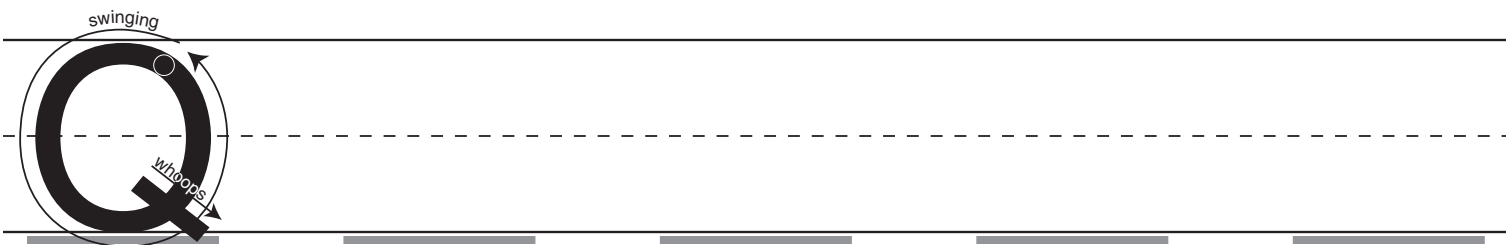

Practice Sheet

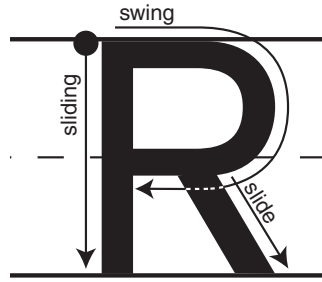
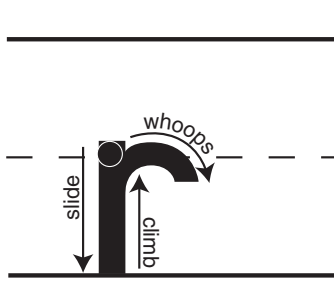

Name _____

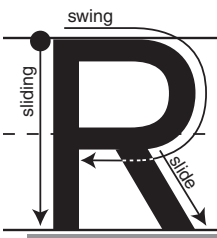
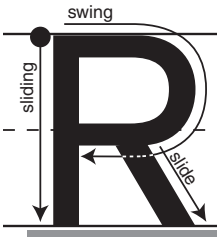
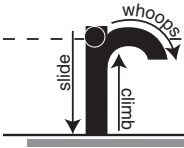
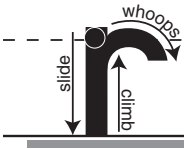

Practice Sheet

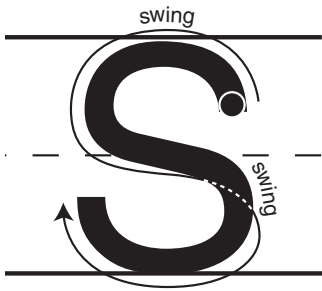
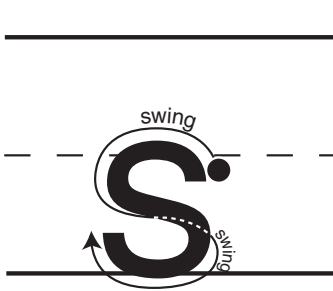

Name _____

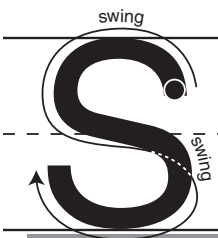
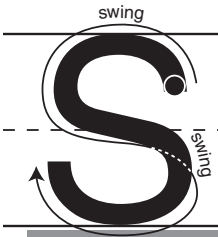
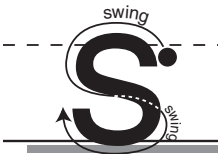
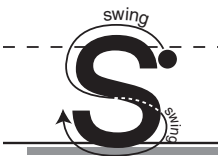

Practice Sheet

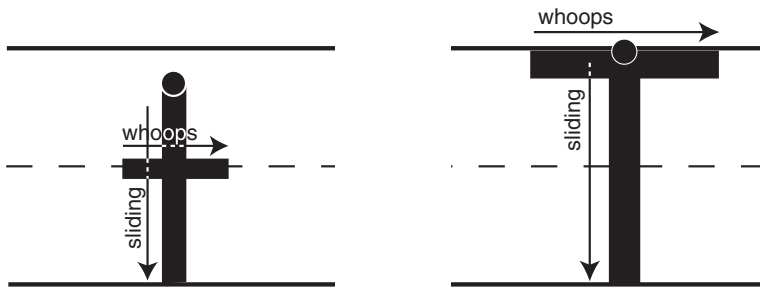

Name _____

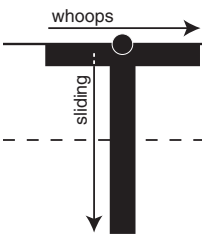
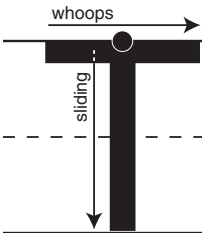
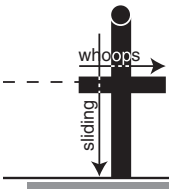
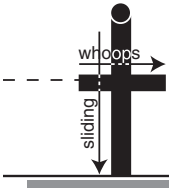

Practice Sheet

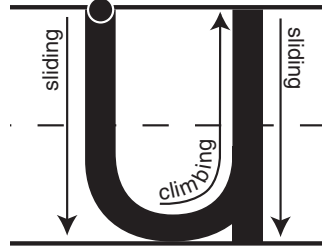
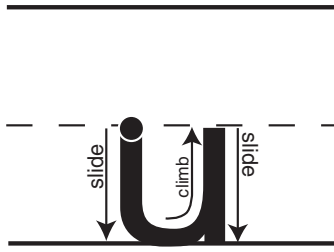

Name _____

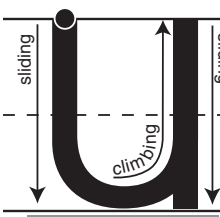
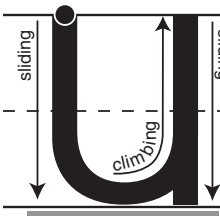
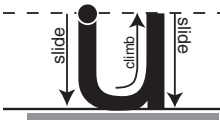

Practice Sheet

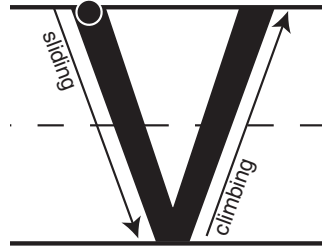
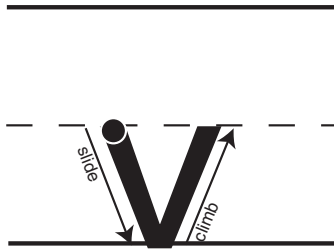

Name _____





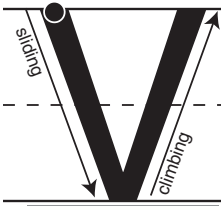

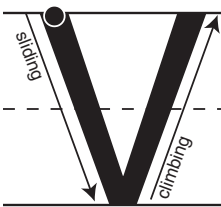

Practice Sheet

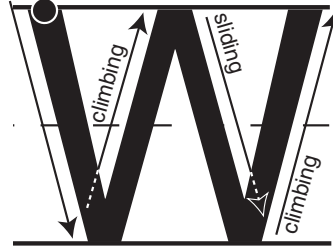
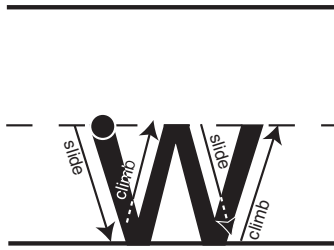

Name _____

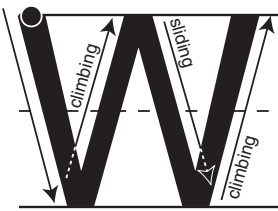
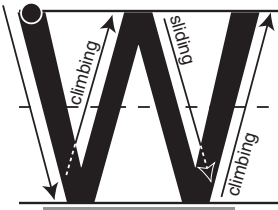

Practice Sheet

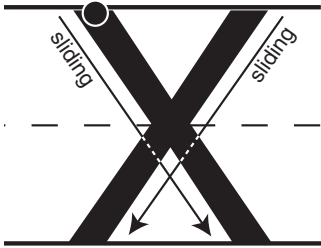
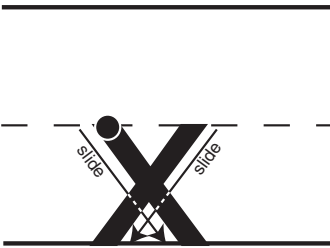

Name _____

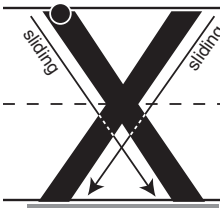
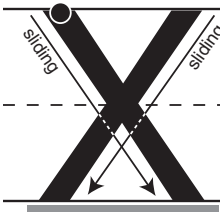

Practice Sheet

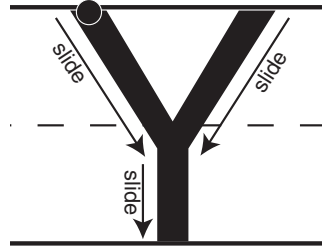
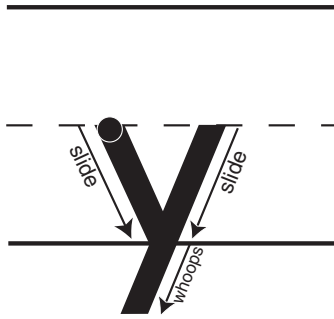

Name _____

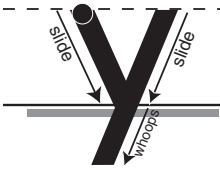

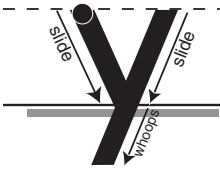

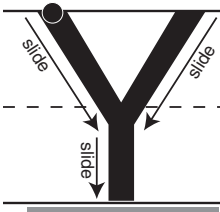

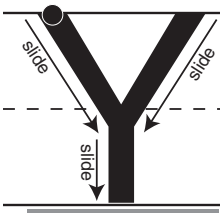

Practice Sheet

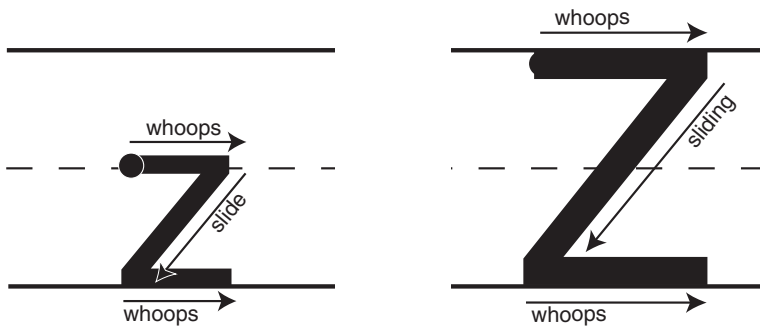

Name _____

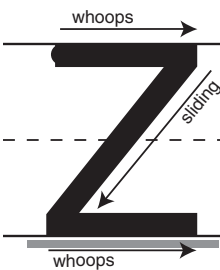
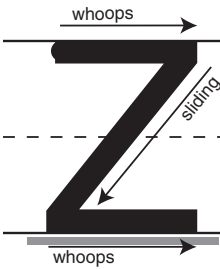
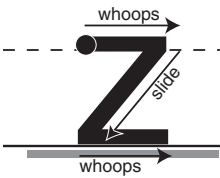
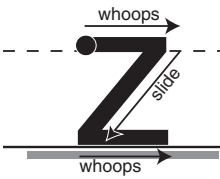

Practice Sheet

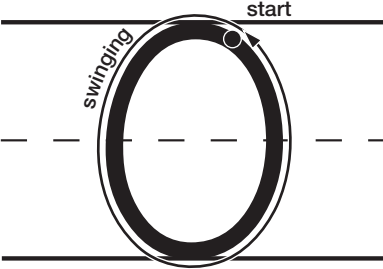

Name _____

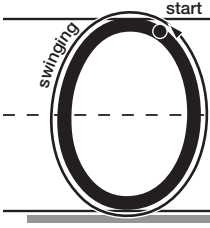
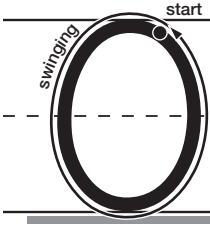
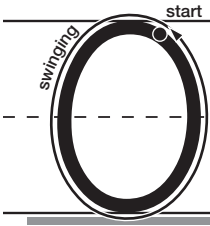
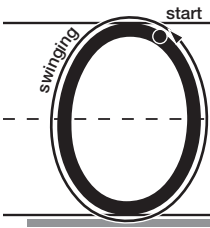

Practice Sheet

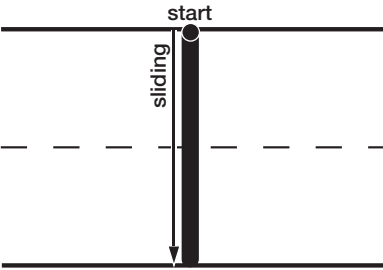

Name _____

A handwriting practice line consisting of a solid top line, a dashed middle line, and a solid bottom line. A vertical line is drawn from the top line to the bottom line, with a downward arrow and the word 'sliding' written vertically next to it. The word 'start' is written above the top line at the beginning of the vertical line. Below the bottom line, there are five short horizontal gray bars.

A handwriting practice line consisting of a solid top line, a dashed middle line, and a solid bottom line. A vertical line is drawn from the top line to the bottom line, with a downward arrow and the word 'sliding' written vertically next to it. The word 'start' is written above the top line at the beginning of the vertical line. Below the bottom line, there are five short horizontal gray bars.

A handwriting practice line consisting of a solid top line, a dashed middle line, and a solid bottom line. A vertical line is drawn from the top line to the bottom line, with a downward arrow and the word 'sliding' written vertically next to it. The word 'start' is written above the top line at the beginning of the vertical line. Below the bottom line, there are five short horizontal gray bars.

A handwriting practice line consisting of a solid top line, a dashed middle line, and a solid bottom line. A vertical line is drawn from the top line to the bottom line, with a downward arrow and the word 'sliding' written vertically next to it. The word 'start' is written above the top line at the beginning of the vertical line. Below the bottom line, there are five short horizontal gray bars.

Practice Sheet

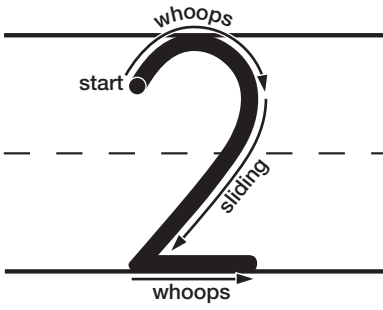

Name _____

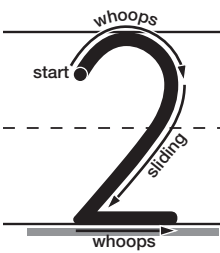
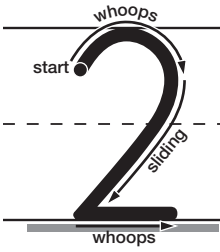
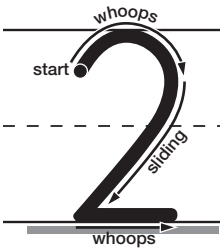
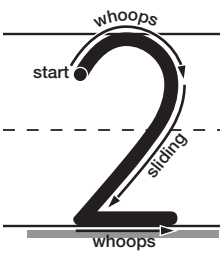

Practice Sheet

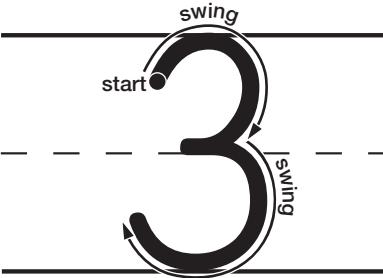

Name _____

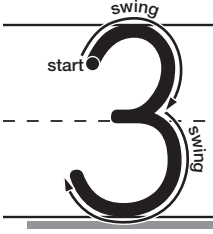
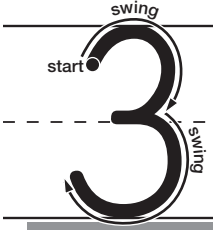
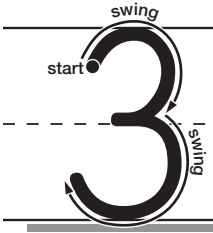
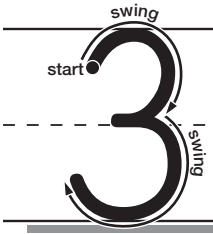

Practice Sheet

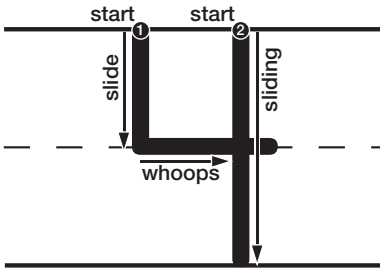

Name _____

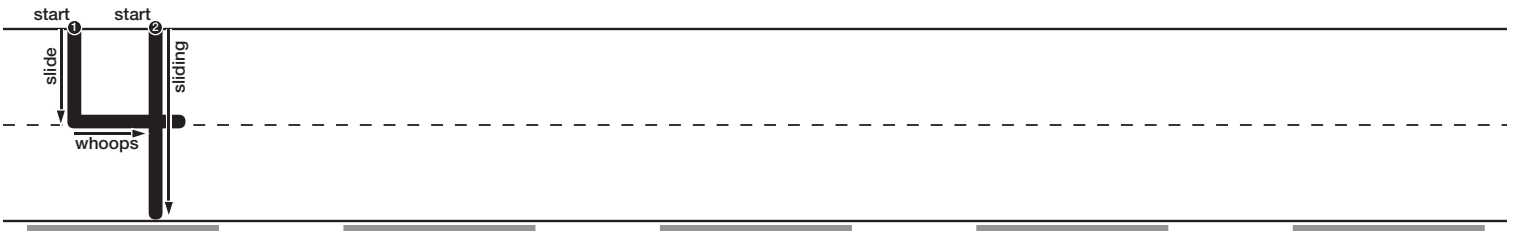
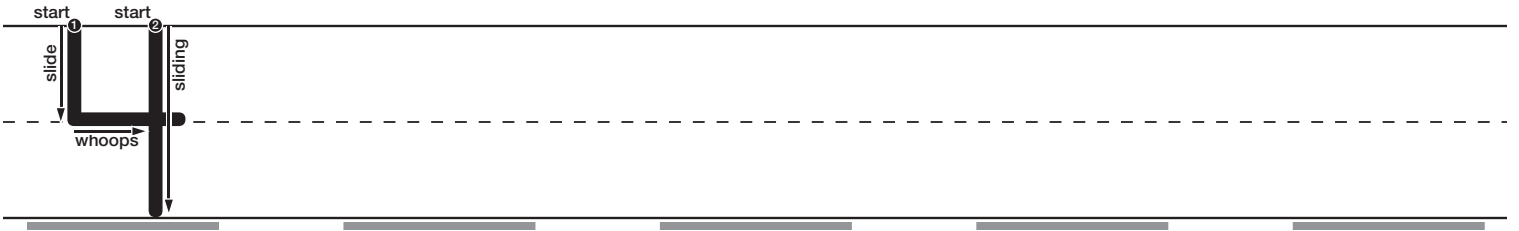
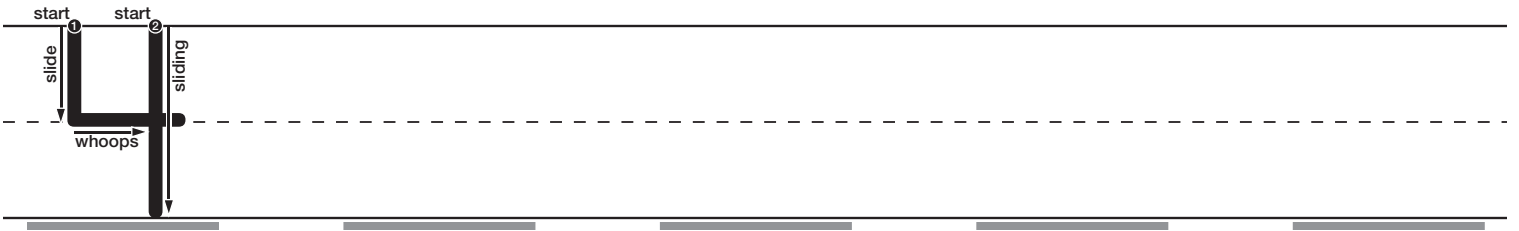
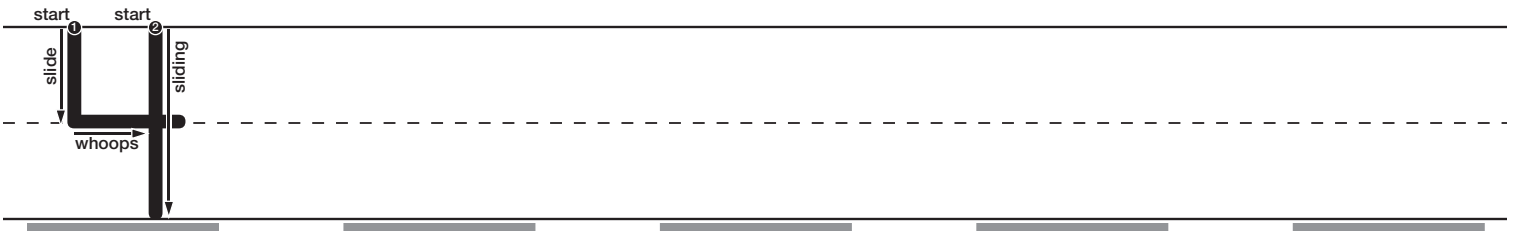

Practice Sheet

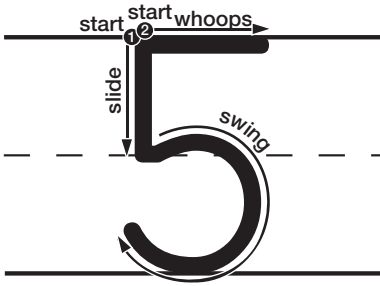

Name _____

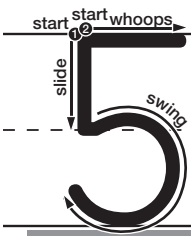
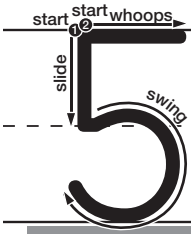
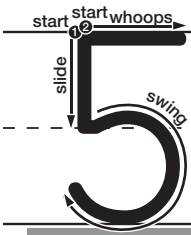
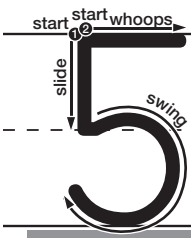

Practice Sheet

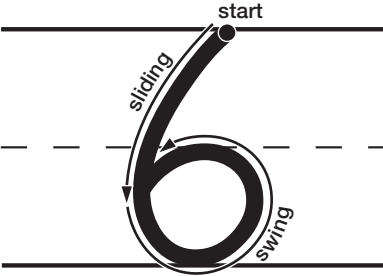

Name _____

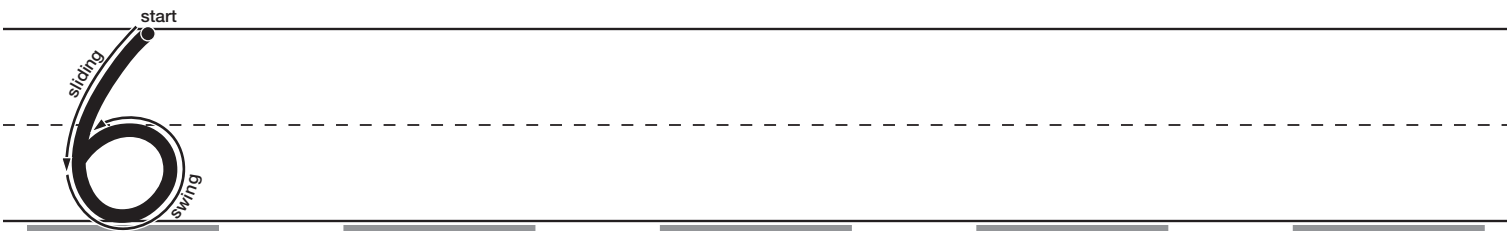
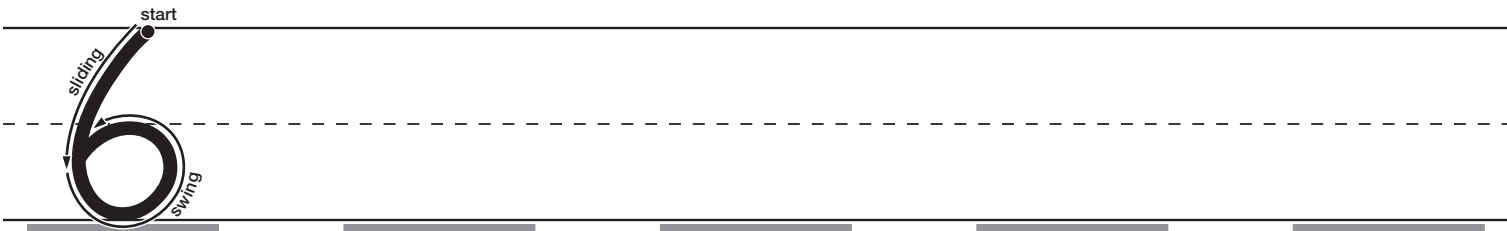
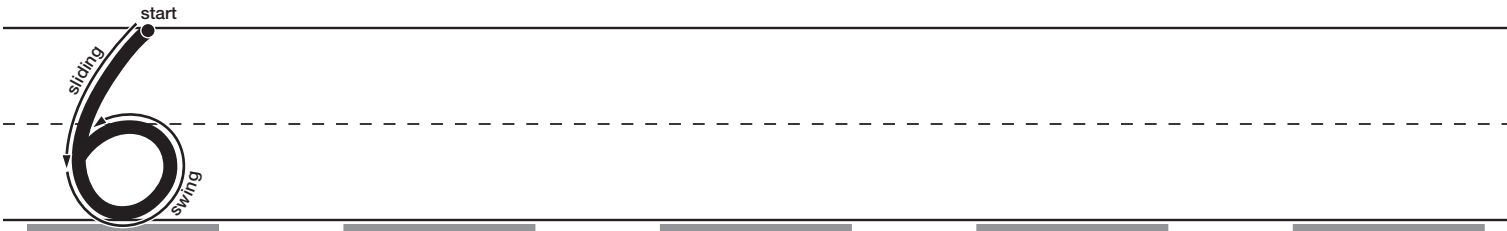

Practice Sheet

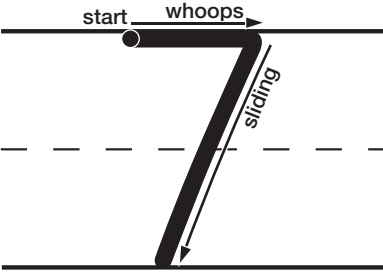

Name _____

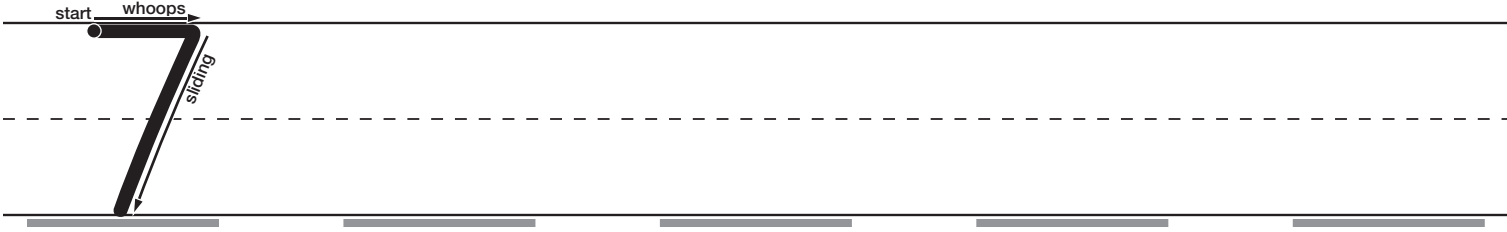
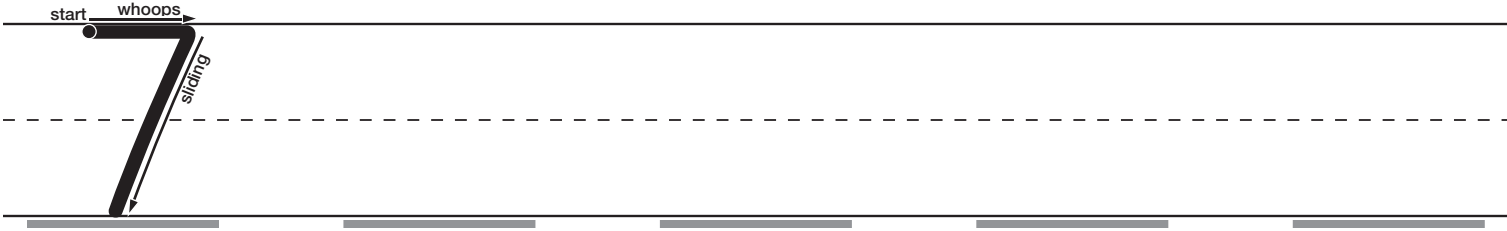
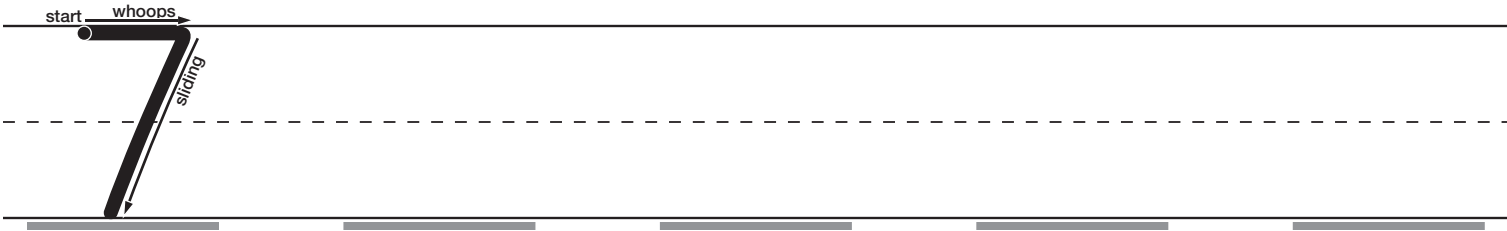
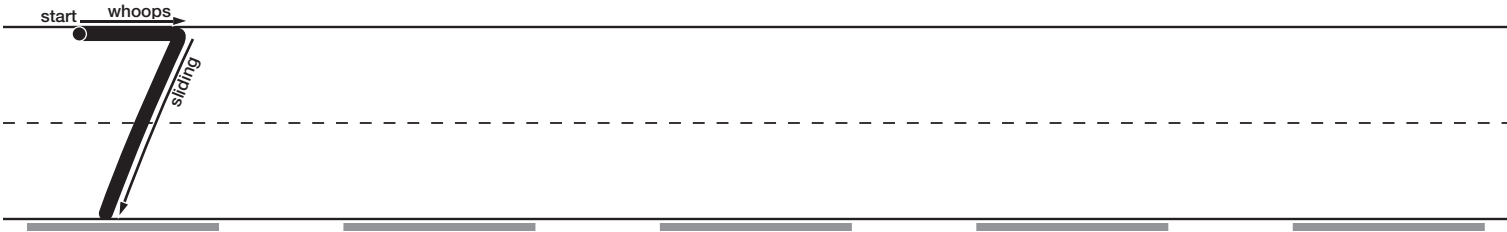

Practice Sheet

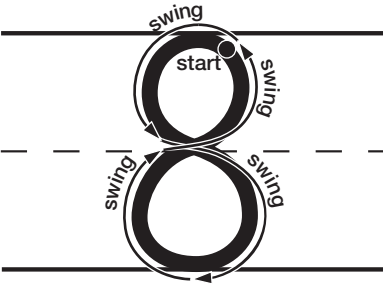

Name _____

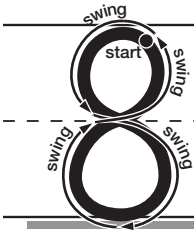
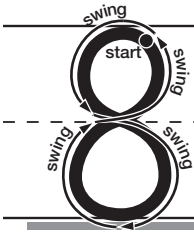
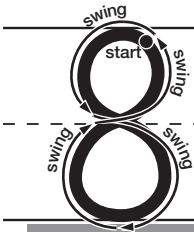
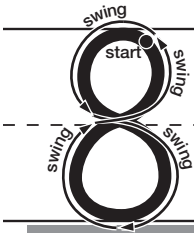

Practice Sheet

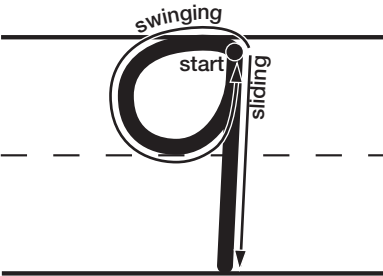

Name _____

